

SPECIFICATIONS

General

Type	Desktop
Paper size	Max. A3 (11" x 17"), min. A5 (5 1/2" x 8 1/2") [min. A6R via bypass]
Paper capacity	Standard: 600 sheets (250 x 2 + 100), maximum: 1,100 sheets
Warm-up time	45 sec.
First copy time*1	7.2 sec.
Memory	Page memory: 32MB Optional memory: 16MB (AR-EB9), 256MB (AR-SM5)
Power requirements	Rated local AC voltage ±10%, 50/60 Hz
Power consumption (max.)	1.2 kW
Dimensions (W x D x H)	590 x 595 x 520 mm (23 1/4" x 23 7/16" x 20 15/32") (excluding optional document cover)
Weight (main unit only)	33.8 kg (74.6 lbs.)

Copier (optional AR-EB9 required for some features)

Copy speed (max.)	20 cpm (A4, 8 1/2" x 11")
Original paper size	Max. A3 (11" x 17")
Continuous copy	Max. 999 copies
Resolution	Scan: 600 x 600 dpi (Photo mode), 600 x 300 dpi (Auto/Text mode) Print: 600 x 600 dpi
Gradation	256 levels
Zoom range	25% to 400% (50% to 200% using SPF/RSPF) in 1% increments
Preset copy ratios	10 ratios (5 reduction + 5 enlargement)
Features	Standard: Auto paper selection, auto magnification selection, auto tray switching, Scan Once/Print Many, XY zoom, dual page copy, offset stack, duplex copy, pre-heat/auto power shut-off modes, toner save mode, copy/print/scan auditing mode*2 (50 accounts total) With optional AR-EB9: Rotation copy, electronic sorting, card shot, margin shift, edge/centre erase, multi-shot (4-in-1, 2-in-1)

Printer (optional AR-EB9 required for some features)

Print speed (max.)	Standard: 12 ppm (host-based) Option: 20 ppm (SPLC) (with AR-EB9)
Resolution	600 dpi
Interface	Standard: IEEE 1284, USB 1.1 Option: USB 2.0 (with AR-EB9)
Supported OS	Windows NT® 4.0 (Workstation SP5 and later), Windows® 2000 (Professional), Windows® XP (Home/Professional), Windows® 95/98/Me
PDL emulation	Standard: Host-based Option: SPLC (with AR-EB9)
Features	Standard: Duplex print, fit to page, image orientation, auto paper selection, rotation print, output tray selection, image adjustment, pure black and white, watermarks, offset print, status window, N-up (2/4) With optional AR-EB9: RIP Once/Print Many

*1: When feeding A4 (8 1/2" x 11") sheets from the paper tray. First copy time depends on the operating environment and the status of use.
*2: AR-NB3 required for print/scan auditing mode.
*3: Resolutions higher than 600 dpi are interpolated.
*4: 300 dpi can be selected only when using the PCL6 or PCL5e printer driver.
*5: AR-PK1N required.
*6: PDF direct printing requires AR-PK1N.
*7: Based on an A4 document with approx. 700 characters at standard resolution in Super G3 mode, 33,600 bps, JBIG compression.

• Design and specifications are subject to change without prior notice.
• Windows and Windows NT are either registered trademarks or trademarks of Microsoft Corporation in the United States and/or other countries. All other brand names and product names may be trademarks or registered trademarks of their respective owners.
• The Energy Star logo is a certification mark and may only be used to certify products that have been determined to meet the Energy Star programme requirements. Energy Star is a US registered mark. The Energy Star guidelines apply to products only in the US, Europe, Australia, New Zealand, and Japan.

Colour Scanner

Scan method	Push scan (via operation panel) and pull scan (with TWAIN-supporting application)
Resolution	600 x 600 dpi (setting range: 50 to 9,600 dpi*3)
Protocols	TWAIN, WIA (Windows XP only), STI
Interface	Standard: USB 1.1 Option: USB 2.0 (with AR-EB9)
Supported OS	Windows 98/Me, Windows XP (Home/Professional), Windows 2000 (Professional)
Scanner utilities	Button Manager, Sharpdesk™

Network Printing/Scanning (optional AR-EB9 and AR-NB3 required)

Resolution	600 dpi, 300 dpi*4
Network interface	10Base-T/100Base-TX
Supported OS	Windows 95/98/Me, Windows NT 4.0 (Workstation SP5 and later), Windows 2000 (Professional)/XP (Home/Professional), Mac OS 8.6 to 9.2.2, Mac OS X 10.1.5, 10.2 to 10.2.8 (excluding 10.2.2), 10.3 to 10.3.4*5
Memory	64MB, max. 320MB with SO-DIMM 256MB (144-pin)
Network protocols	TCP/IP, IPX/SPX (Netware), NetBEUI, EtherTalk (AppleTalk)
Available fonts	80 fonts for PCL, 136 fonts for PS3 emulation*5
Features	PCL 6/5e and PS3*5 emulation, printer administration utility, printer status monitor, PDF/TIFF direct printing*6, network scan (scan to e-mail/FTP server/desktop), LDAP, IP/MAC address filtering
File formats	JPEG, PDF, TIFF

Facsimile (optional AR-FX11 required)

Compression method	MH/MR/MMR/JBIG
Communication protocol	Super G3/G3
Transmission time	Less than 3 seconds*7
Modem speed	33,600 bps to 2,400 bps with automatic fallback
Transmission resolution	Standard: 8 dots x 3.85 lines/mm Ultra Fine: 16 dots x 15.4 lines/mm
Recording width	A3 to A5 (11" x 17" to 5 1/2" x 8 1/2")
Memory	2MB flash memory Optional memory: 8MB (AR-MM9)
Greyscale levels	Equivalent to 256 levels
Features	Rapid and group dials (50 in total), 300 speed dials, 9 job programmes, broadcasting (200 destinations), memory transmission/reception, quick on-line transmission, auto reduction (transmission/reception), rotation transmission/reception, long original transmission (max. 800 mm), divided reception, duplex reception, timer transmission, polling, F-Code compatibility (confidential, relay broadcast, polling), auditing mode (50 accounts)

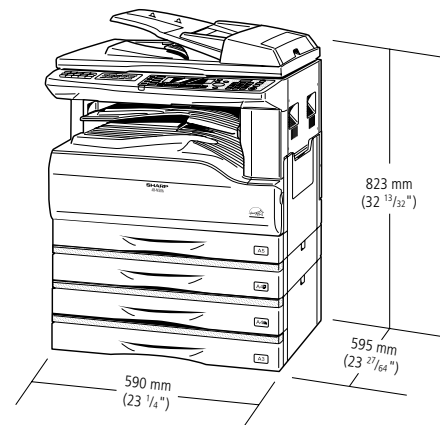

Multifunction power with colour scan, fax, and duplexing



Distributed by:

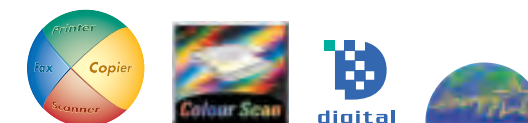

One compact solution answers your individual office needs



COPYING



Need a simple solution for keeping up with today's fast-paced and graphic-intensive business communications? The AR-M206 has all your everyday office needs covered in one efficient document solution that delivers outstanding copying and printing, and brilliant colour scanning. In addition to its wide range of superb functions, the AR-M206 offers a world of performance-boosting options for you to choose from: Super G3 faxing, powerful network scanning and printing, advanced copy/print functions, and more. Since you can choose the system configuration best suited to your office needs, the AR-M206 brings you everything you need — with the flexibility to grow. Conveniently packaged in a compact and user-friendly design, the AR-M206 delivers the versatility and ease-of-use that today's businesses are looking for.

• Productive Copying

- Quick copy speed of max. 20 cpm
- Scan Once/Print Many function and optional electronic sorting
- Built-in stackless duplex module
- Optional 40-sheet SPF (single pass feeder) or reversing SPF
- Max. 1,100-sheet paper capacity
- Added functions with optional Dual Function Board

• Performance Printing

- Standard printing at 12 ppm, upgradeable to 20 ppm
- RIP Once/Print Many function for productive printing (option)
- Speed-enhanced Sharp Printer Language with Compression (option)
- Smart sharing with three PCs via IEEE 1284, USB 1.1, and optional USB 2.0
- Upgradeable to network printing with network utilities
- IP/MAC address filtering prevents unauthorised access (option)

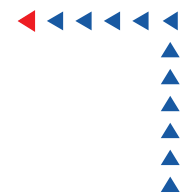
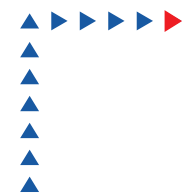
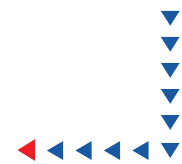
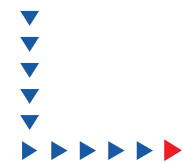

• Colour Scanning

- Full-colour scanning at 600 dpi and up to A3 in size
- Sharpdesk™ provides easy desktop management of documents in over 200 file types
- Button Manager for quick and easy scanning
- Upgradeable to network colour scanning (scan to e-mail/desktop/FTP server)
- LDAP compatibility for easy browsing of e-mail addresses

• Speedy Faxing (option)

- Super G3 faxing and JBIG compression
- Quick on-line transmission
- Duplex fax transmission and reception
- Max. 300 speed dials

• User- and Environment-Friendly

- Universal design concept and 5-line LCD operation panel
- Energy-efficient design
- Lead-free wiring harnesses and AC power cords
- Chromium-free surface-treated steel sheet

Speedy Copying and Quick First Copy Time

The AR-M206 has a quick first copy time of **7.2 seconds*** to save valuable time when performing multiple short-run jobs. And with a continuous copy rate of **20 cpm** (A4 size [8 1/2" x 11"]), you can do more copy jobs in less time.



*Depends on the operating environment and the status of use.

Paper Capacity

The AR-M206 comes standard with two 250-sheet paper trays and a 100-sheet multi-bypass feeder. Two types of extra paper drawers are available for a total paper capacity of up to **1,100 sheets**.



Scan Once/Print Many and Optional Electronic Sorting

The AR-M206's Scan Once/Print Many (SOPM) function does one scan of multiple-page documents and stores them in memory for making up to **999 copies** of each page. The optional AR-EB9 Dual Function Board increases efficiency with an Electronic Sorting function, which **automatically collates** multiple sets of copies in page order without the aid of a sorter. The AR-M206 also stacks each set slightly shifted apart from the previous (**offset stacking**) for easy retrieval. All this adds up to speedy copying that boosts productivity even for large-volume documents.

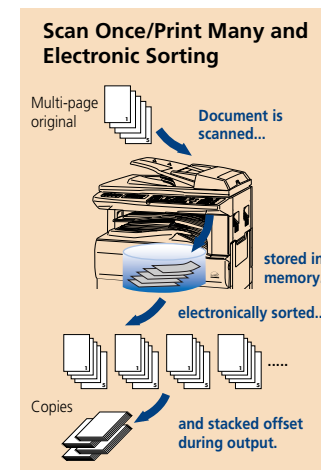

Built-in Duplex Module and Optional RSPF

The AR-M206 can automatically produce **duplex copies** from one- or two-sided originals. This reduces paper costs and helps save filing space. Duplex copying is even more productive when used together with the **optional RSPF** (reversing single pass feeder),

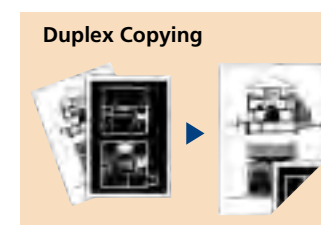

which efficiently feeds in up to **40 pages** of either one- or two-sided originals. A **40-sheet SPF** (single pass feeder) is also available for feeding in one-sided originals.



Versatile Editing Functions

The AR-M206 is standard equipped with Dual Page Copy Mode and XY Zoom. Additional image editing functions are available with the optional AR-EB9 upgrade that make copying even more convenient.

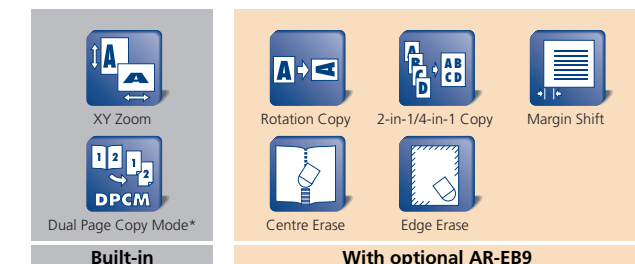

*Not available when using RSPF or SPF.

Card Shot (option)

This function enables one-touch scanning and copying of both sides of a card (credit cards, ID cards, etc.) onto a single page.

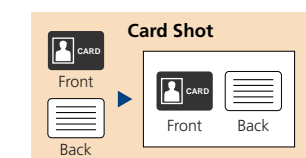

Note: Not available when using RSPF or SPF.

Superb Image Quality

600 dpi resolution and 256-level greyscale ensure finely detailed reproduction, while **Digital Auto Exposure Control** provides optimum copy contrast. For the best results, users can select **Text mode** for text-only originals or **Photo mode** that gives detailed, high-quality reproduction of photos and delicate halftone images.

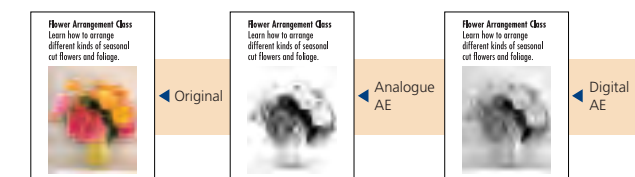

Other Key Features

- Wide zoom range from **25% to 400%** with 10 preset ratios
- Automatic paper/magnification selection
- Copy/print/scan auditing (50 accounts total)
- Cost-efficient Toner Save mode

PRINTING

Speedy Printing with Sharp Technology

The AR-EB9 Dual Function Board brings the AR-M206 the power of Sharp Printer Language with Compression (SPLC) printing. SPLC effectively reduces the data size of print jobs, speeding up the data transfer time and printing process while improving overall throughput. The AR-EB9 also provides **RIP Once/Print Many** (ROPM) memory for efficient processing. Documents are output at a quick rate of **20 ppm** (A4 size) in 600 dpi resolution.



SPLC (Sharp Printer Language with Compression) Printing

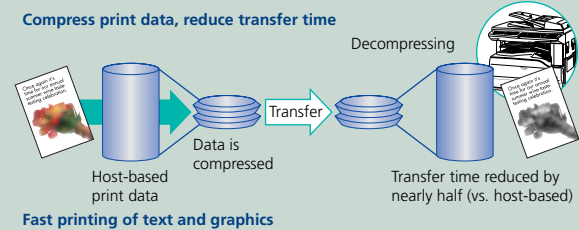

Smart Sharing

The AR-M206's Smart Sharing function allows you to connect multiple computers directly to the machine without having to go through a network. This is great news for small workgroups that need to share the unit with only a few PCs and don't have a LAN set up in their office. **One USB 1.1 port** and **one IEEE 1284 port** are provided as standard, and a **USB 2.0** interface can be added with the AR-EB9 for a total of three PC connections.

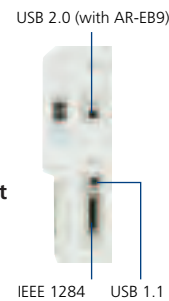

Job Offset and Job Separator

The AR-M206 ensures your documents will stay neatly organised even when others are sharing the machine. To make it easier to locate and retrieve your documents from the tray, the AR-M206's **Job Offset** function stacks each print job slightly shifted apart from one another. In addition, the optional AR-TR4 **Job Separator Tray Kit** lets you send printer output to the Job Separator tray or beneath it, preventing your job from getting mixed in with copies and faxes.

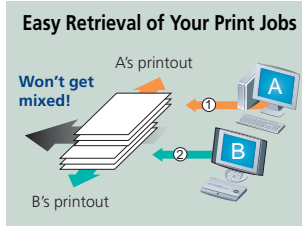

Printer Status Window

A Printer Status Window conveniently allows you to monitor important printer information on your PC, including on-line/off-line status, name of the active print job, and machine conditions such as the amount of paper or toner.



Printer Status Window

Other Key Features

- Standard host-based printing at max. 12 ppm
- N-up, Fit-to-Page, watermarks
- Duplex printing

NETWORK PRINTING (option)

Network functions require both the AR-EB9 and AR-NB3.

Powerful Network Printing

The AR-M206 can be optionally upgraded into a network printer that supports TCP/IP, IPX/SPX, NetBEUI for Windows, and Macintosh EtherTalk, enabling your entire office to benefit from powerful network printing. **PCL 6/5e** printer language emulations are also provided. For compatibility with more fonts and better graphics handling, **PostScript 3** emulation is available with the optional AR-PK1N PS3 Expansion Kit.

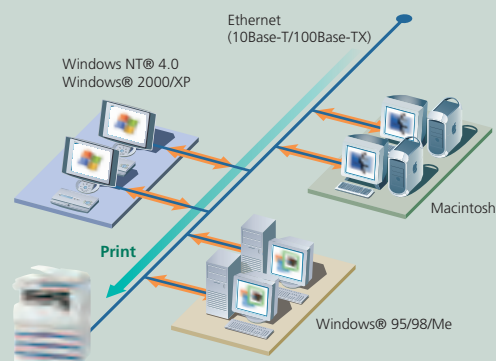

Network Utility Software

Sharp's original **Printer Administration Utility** software makes printer networks easier to manage by allowing network administrators to customise monitored items and view settings such as the IP address directly from their PC. And with the **Printer Status Monitor**, network PC screens can display printer conditions, such as toner levels and whether there is any paper remaining.

IP/MAC Address Filtering for Security

The IP/MAC address filtering function provides highly secure operation by restricting access to the AR-M206 on your office network. Only PCs that have either their **IP address** or **MAC (media access control) address** registered are allowed to use the AR-M206. Attempted access from an unknown IP or MAC address will be denied, preventing unauthorised use.

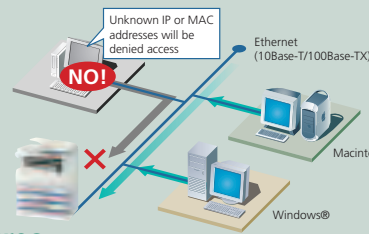

Other Key Features

- Barcode font compatibility (requires AR-PF1)
- PDF/TIFF direct printing (PDF direct printing requires AR-PK1N)

COLOUR SCANNING

A3 Full-Colour Scanning

The AR-M206 lets you easily scan colour originals in **600 x 600 dpi** resolution and use them to create vivid, impressive colour documents or presentation materials. The optional 40-sheet RSPF or SPF gives efficient multi-page document scanning. The AR-M206's high-quality colour CCD with wide depth of focus gives you clear, full-colour scanning of originals with uneven surfaces*, such as fabric and documents with other paper pasted on top. This means more creative possibilities and more ways to communicate accurately and effectively.



*There are limits (height, width, and depth) to uneven-surface objects that can be scanned.

Push and Pull Scanning

Operation is quick and easy — simply press the Scan button, select an application, and press Start (**push scan**). Up to six pre-registered applications are available, including Sharpdesk™, e-mail*, Microsoft® Word*, OCR*, and fax*. **Button Manager** software allows you to change/assign these destination applications and scan settings. The AR-M206's scanner driver is also compatible with the **TWAIN** standard, allowing it to be used with various TWAIN-compliant applications (**pull scan**).

*These applications require additional software.

Sharpdesk™ — Document Management on Your PC

Sharpdesk™ is an original Sharp application that provides integrated desktop management of documents in over **200 file formats**, including scanned paper-based documents and those created with popular applications such as Word. It allows you to organise, edit, search, and distribute your documents, all with simple drag-and-drop operation.

- Intuitive desktop display features **thumbnail** viewing
- Sharpdesk Imaging provides **annotation** tools for paper-free proofreading
- Sharpdesk **Composer** combines different types of files into a single document
- **Optical character recognition** converts documents into editable text files
- **Output zone** distributes files to e-mail, printers, and other applications
- **File search** allows searching by file name, keyword, or thumbnail

Note: Sharpdesk is not compatible with Windows® 95 and Windows NT® 4.0 (Service Pack 5.0).

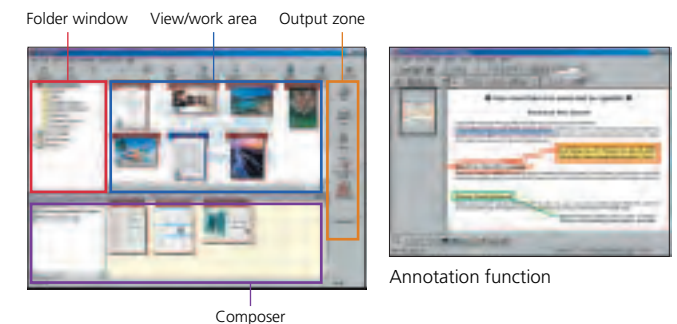

FULL-COLOUR NETWORK SCANNING (option)

Network functions require both the AR-EB9 and AR-NB3.

Scan to Desktop, E-Mail, or FTP Server

The AR-M206 can be optionally upgraded into a convenient full-colour network scanner. As easy as making a copy, you can send scanned images anywhere over the network. Scanned files can be forwarded directly to your PC* (scan to desktop), sent as an attachment to any e-mail address over the Internet (scan to e-mail), or stored on a file server where they can be easily accessed from any PC on the network (scan to FTP server).

*Network Scanner Tool and Sharpdesk™ must be installed on the PC.

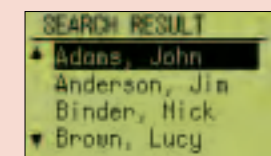
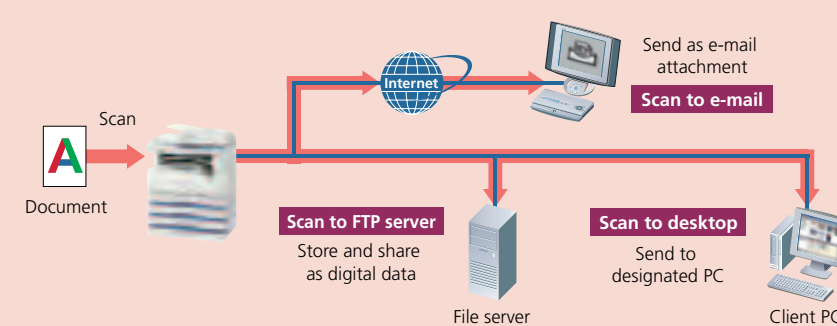

LDAP search results

FAXING (option)

USER- AND ENVIRONMENT-FRIENDLY

High-Speed Operation

The AR-FX11 Fax Expansion Kit turns the AR-M206 into a **Super G3 fax** machine featuring a fast modem speed of 33.6 Kbps. Using JBIG data compression, the AR-M206 can send an A4 (8 1/2" x 11") size page in under 3 seconds*. When used with the optional 40-sheet RSPF, your faxing jobs become even more efficient.



*Based on an A4 document with approx. 700 characters at standard resolution.

Quick On-Line Transmission

The AR-M206 starts dialling and transmitting a multi-page document as soon as the first page is scanned into memory. This greatly reduces the overall time it takes to send the document.

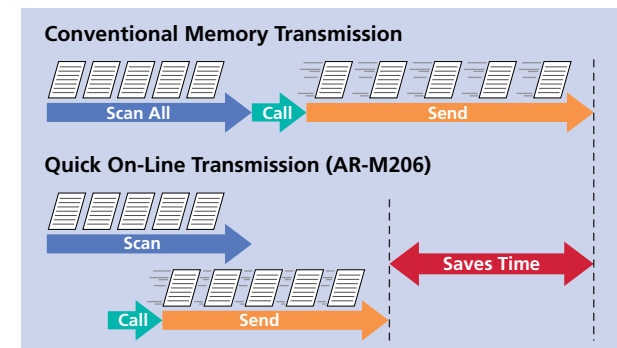

Job Separator

With the optional AR-TR4 Job Separator Tray Kit installed, you can do copy jobs while receiving incoming faxes without them getting mixed together.

Note: Output destinations can be designated, placing fax or printer output onto the Job Separator tray and copier or printer output onto the bottom tray.

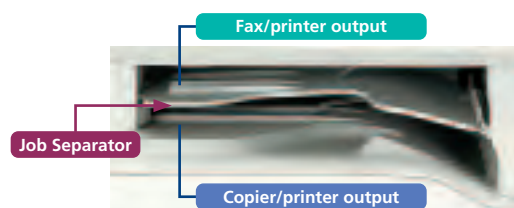

PC-Fax Transmission

A PC-Fax function allows you to directly send a document created on your PC to a recipient's fax machine via the AR-M206. Since all faxing procedures are done on your PC without printing to paper, this function saves time, increases faxing productivity, and retains original document quality.

Note: Consult your local Sharp dealer for the date of availability.

Duplex Transmission and Reception

With the optional RSPF, the AR-M206 scans both pages of two-sided documents and sorts them in memory. The pages are then transmitted in the proper order. Thanks to the built-in duplex module, the AR-M206 can also print incoming faxes onto both sides of the paper, thus saving you paper costs.

Auto Dialling

The AR-M206 stores up to **50** frequently called numbers (including Group dials) for instant one-touch Rapid Dial connections and up to **300** numbers for three-digit Speed Dialling.

Fax Reception Light

The AR-M206 lets you know when an incoming fax has been received with an LED on the corner of the operation panel that blinks until the user retrieves the fax from the Job Separator tray*.



*When the Job Separator tray is not installed, the LED stops blinking when the received fax has finished printing.

Other Key Features

- **F-Code Communication** enables confidential communication, relay request transmission, and memory polling with fax machines from other brands that conform to the ITU-T F-Code (sub-address and pass code) standard
- **Automatic Reduction** automatically reduces the size of the document being sent or received to fit the paper size of the recipient machine or the AR-M206
- **Memory Transmission/Reception** stores documents in memory, allowing the originals to be returned to the user quickly and saving incoming faxes in memory if the AR-M206 runs out of paper or toner
- **Timer Transmission** enables unattended after-hours operation when reduced phone rates are in effect
- **Polling** allows the user to retrieve a document left in the feeder of a remote fax machine
- **Long originals** (up to 800 mm long) can be sent using the RSPF/SPF
- **Broadcast** faxing to up to 200 locations
- **Programme keys** (up to 9 keys) are available to set up frequently used transmissions for instant recall
- **Rotation Reception/Transmission** rotates incoming or outgoing faxes to match the direction of the printing paper size
- **Divided Reception** prints out long-length faxes onto separate sheets of paper

Operation Panel

The AR-M206's operation panel is created under a **universal design** concept, making it easy for everyone to use, from office equipment novices to the physically challenged.

- New easy-to-read 5-line LCD
- Optimum-height operation panel for easy access
- Easy-to-press and -feel indented keys
- Notification sounds for default levels in manual settings (zoom, exposure, etc.)
- Delayed response setting gives enough time to cancel operation



Environmentally Conscious Design

- The AR-M206 conforms to the **Energy Star** programme, an international system identifying energy-efficient products that conserve natural resources and reduce environmental pollution.
- The AR-M206 has two levels of **energy-saving modes**, Pre-Heat and Auto Power Shut-Off, to reduce or shut off electricity used in the fusing unit after a period of inactivity. These modes save running costs while the machine is not in use.
- The AR-M206 uses **chromium-free** surface-treated steel sheet and **lead-free** wiring harnesses and AC power cords.

System Configuration

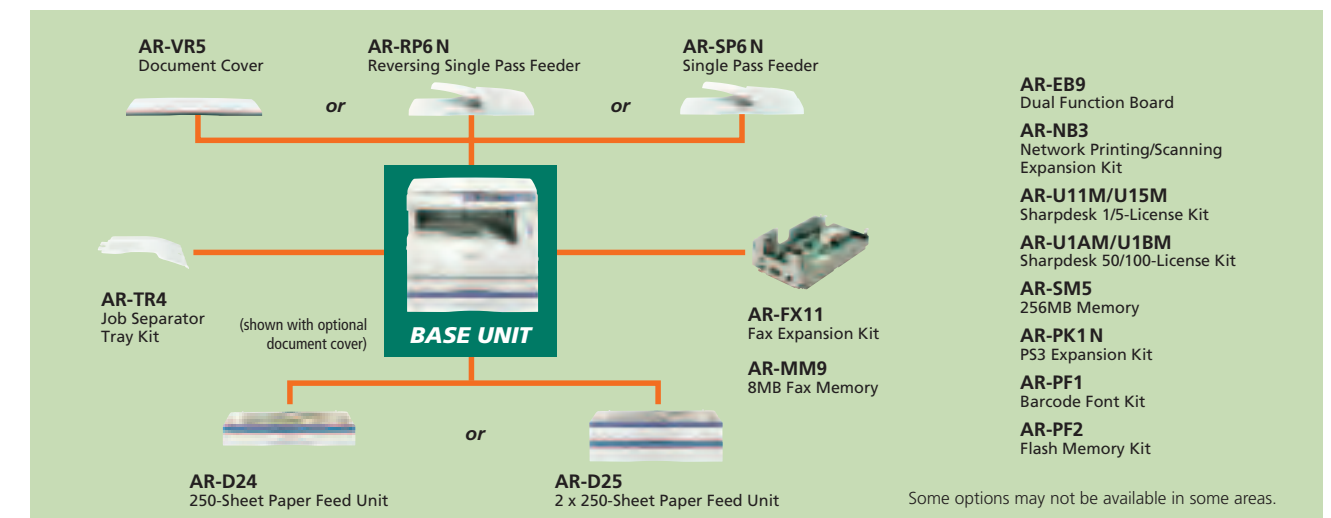

Software Options to Expand the AR-M206's Key Features

	COPY	PRINT	SCAN	FAX	SECURITY
Base Unit (AR-M206) USB 1.1, IEEE 1284	Max. 20 cpm, duplex	12 ppm (host-based), duplex	Full colour, Sharpdesk™	–	Copy auditing
AR-EB9 USB 2.0	E-sort, extra image editing	20 ppm (SPLC), ROPM	–	–	–
AR-NB3 10Base-T, 100Base-TX	–	Network printing, PAU, status monitor, PCL6/5e, TIFF direct printing	Network colour scanning, LDAP	–	IP/MAC address filtering, print/scan auditing, network port/protocol management
AR-PK1N	–	PS3, PDF direct printing	–	–	–
AR-PF1/PF2	–	Barcode fonts, font & form download	–	–	–
AR-FX11	–	–	–	Super G3, PC-fax*	Fax auditing

*Consult your local Sharp dealer for the date of availability.